

FEATURES	
<ul style="list-style-type: none"> • Combines linear and nonlinear measurements • Measures linear transfer function and harmonic distortions simultaneously • Fast two channel data acquisition (< 43,6 kHz) with noise floor monitoring • Automatic SPL calibration • Highly adjustable stimulus (bandwidth, spectrum, crest factor) 	<ul style="list-style-type: none"> • Provides impulse response and energy-time curve (ETC) • Quasi-anechoic measurement due to windowing of impulse response • Calculates time delay, minimal phase and group delay • Provides cumulative spectral decay (CSD) and sonograph Overlay of up to 20 result curves

The TRF module measures two signals simultaneously, and determines the magnitude and phase of the linear transfer function and the harmonic distortion at the same time. The stimulus is a logarithmic sweep with adjustable spectrum, bandwidth and crest factor. Window techniques (gating) applied to the impulse response allows a separation of the direct sound from early reflections, diffuse field and nonlinear artifacts. Finally, post-processing provides the time delay (zero delay plane), minimal phase, group delay and several frequency-time transformations (e.g. cumulative spectral decay and sonograph).

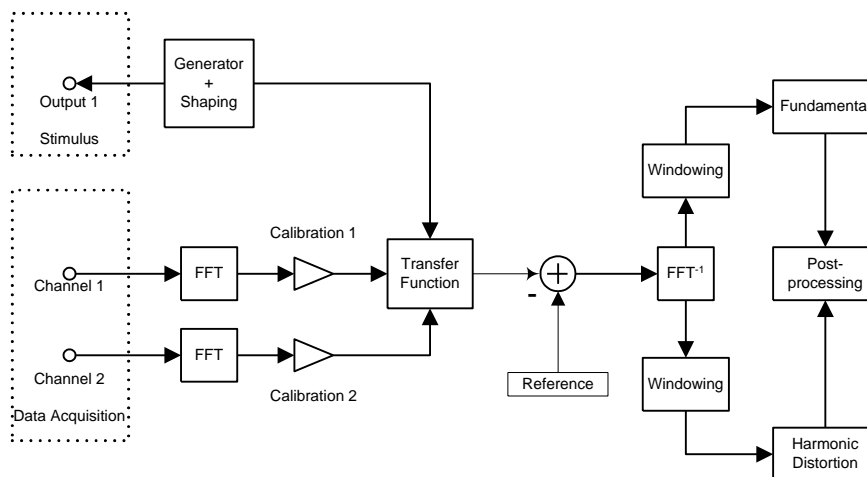

Article Number: 1000-900

CONTENT:

1	Excitation Signal (Stimulus)	3
2	Signal Acquisition	3

3	Post-processing	4
4	Graphical representation	5
5	Result Windows.....	5
6	Limit Values	6
7	Applications.....	7
8	Patents	9

1 Excitation Signal (Stimulus)

Stimulus	The module uses a logarithmic sine sweep excitation signal. The logarithmic sine sweep is an optimal excitation signal as it gives the highest signal to noise ratio and produces no modulation distortion. It allows to separate the linear transfer response and harmonic distortion components. The linear transfer response can so be purified from nonlinear artifacts. Furthermore frequency plots of the individual harmonic distortion components can be extracted from the measurement data.
Frequency band	The start frequency f_{\min} and the end frequency f_{\max} of sine sweep can be selected in the range from 0.05 Hz to 43,6 kHz .
Resolution	The user may specify the analysis resolution or the corresponding duration of the sweep. The required sample frequency and signal length are selected automatically according to the desired frequency band and resolution.
Voltage	The user may specify either the voltage at the output connector OUT 1 (OUT 2) or the voltage at the terminals of the speaker connected to output SPEAKER 1 (SPEAKER 2). In the later case the amplifier gain is determined at 750 Hz without load prior to the main measurement and the excitation level is adjusted accordingly.
Shaping of the stimulus spectrum	The magnitude of the stimulus spectrum can be arbitrarily shaped by the user (e.g. to attenuate low frequencies to protect tweeters). For this a shaping curve may imported from the clipboard. For security reasons the shaping curve is automatically scaled before applying it to the stimulus. The scaling limits the maximal shaping factor to 0 dB, i.e. the stimulus amplitude will never be increased. The shape of the spectrum determines the crest factor of the waveform. The default shape of the stimulus spectrum yields to the optimal crest factor of 3dB.
Signal length	Maximal 128k samples synchronous to FFT length

2 Signal Acquisition

Signal acquisition	Two-channel acquisition synchronous to stimulus and FFT length (max. 128k samples)
Channel 1	Signal at connector IN1 (microphone) or voltage at speaker terminals (of Speaker 1 or Speaker 2)
Channel 2	Signal at connector IN2 (microphone) or current at speaker terminals (of Speaker 1 or Speaker 2) or signal of laser displacement sensor
Calibration curve	A calibration curve can be imported from the clipboard for each signal type that can be measured on channel 1 and channel 2.
Calibration factor	The user can specify a calibration factor for converting physical units to dB for each signal type that can be measured on channel 1 and channel 2.
Noise floor monitoring	Prior to the main measurement a noise floor measurement can be performed to monitor system noise and to ensure sufficient excitation.
Averaging	The measurement may periodically be repeated 2-256 times. The resulting waveforms are averaged to reduce noise.
Automatic SPL calibration	An automatic procedure is provided to calibrate the TRF for SPL measurements with a pistonphone or calibrator. All the user has to do is to enter the sound pressure level produced by the pistonphone. The user can choose between actually calibrating the TRF and validating the current calibration.
Continuous loop measurements	A special mode of operation allows repetitive measurements without starting each measurement individually. The time between the individual measurements

	can be specified by the user.
--	-------------------------------

3 Post-processing

Spectral Analysis	The spectrum of the signals acquired on channel 1 and channel 2 is calculated and plotted together with the noise floor.
Windowing	Rectangular, Cosine, Hanning, Hamming, Blackman and Kaiser windows are provided as full (symmetric) and half (asymmetric) windows respectively. The window is applied to the selected range of the impulse response. Furthermore it is used to calculate the time-frequency transformations.
Denominator and nominator of transfer function	Several transfer functions can be calculated from the measured data (without measuring again), i.e. <ul style="list-style-type: none"> • signal channel 1 / stimulus • signal channel 2 / stimulus • signal channel 1 / signal channel 2 • reciprocal of the above transfer functions
Impulse response (linear + nonlinear)	The module calculates the impulse response for the selected transfer function. Using two markers the user can select a section of the impulse response for analysis in order to separate direct sound from early reflections and diffuse field. Due to the logarithmic sine sweep excitation the linear and the nonlinear response are separated (if stimulus is selected as transfer function denominator). Using the markers the nonlinear response can be excluded and the transfer function purified from nonlinear artifacts.
Energy-time curve (ETC)	Magnitude of the envelope of the impulse response given in dB. In this representation the direct sound can usually be determined more clearly than in the impulse response.
Linear transfer function	The transfer function is calculated for the selected section of the impulse response. The following representations are provided: <ul style="list-style-type: none"> • Magnitude (Bode plot) • Phase (Bode plot) • Nyquist plot (imaginary part vs. real part) Due to the logarithmic sine sweep excitation the transfer function can easily be purified from nonlinear artifacts.
Fundamental + Harmonics	Magnitude of fundamental, harmonic distortion components (2 nd to 24 th order).
Harmonic distortion	Ratio of harmonic distortion components (2 nd to 24 th order) and the fundamental
Reference	The measurement can be referred to some reference measurement. For this the transfer function can be divided by a reference curve imported from the clipboard. Furthermore the measurement can be referred to a scalar reference value given in dB.
Time delay (zero delay plane)	Time delay present in the transfer function. The time delay can be determined automatically or specified by the user. The time delay can be converted to the corresponding distance = time delay * sonic speed.
Minimal phase	Minimal phase of transfer function calculated by the Hilbert transformation.
Excess phase	Excess phase of transfer function (phase - minimal phase - effect of time delay)
Group delay	Total group delay (negative derivative of transfer function phase) Excess group delay (negative derivative of excess phase)
Cumulative spectral decay	CSD plot of transfer function. Illustrates the decay of the individual frequency components after exciting the system with a sine that is suddenly switched off.

(CSD)	
Wigner distribution	Wigner distribution of the transfer function
Sonograph	Sonograph of the transfer function. A short symmetric data window is used to separate the impulse response into joined sections. The plot shows the spectra of the sections vs. frequency and time.

4 Graphical representation

Spectral Analysis	<p><u>Curve post-processing:</u> Spectra can be plotted</p> <ul style="list-style-type: none"> integrated (RMS sum) over IEC standard 1/3 octave and octave bins respectively or without post-processing. <p><u>Noise floor:</u> The result of the prior noise floor measurement is plotted together with the spectral lines of the signal</p>
Transfer function	<p><u>Effective resolution:</u> The effective frequency resolution depends on the window length and type applied to the impulse response. In all transfer function related plots results are shown only for frequencies above the relative resolution.</p> <p><u>Curve post-processing:</u> Transfer function related curves can be plotted</p> <ul style="list-style-type: none"> averaged over IEC standard 1/3 octave and octave bins respectively, smoothed (moving average) over $1/n^{\text{th}}$ octave ($n=1,2,\dots,99$) or without post-processing. <p><u>Units:</u> Transfer function related curves can be plotted</p> <ul style="list-style-type: none"> in real physical units (linear or logarithmic), in dB or in level meter style (fixed x-axis from 10 Hz to 40 kHz, y-axis in dB with dynamic range fixed to 50 dB).
Harmonic distortion	<ul style="list-style-type: none"> in percent or in dB (100 % corresponds to 0 dB)
Phases	<ul style="list-style-type: none"> wrapped unwrapped

5 Result Windows

h(t) Impulse Response	Shows the measured and the windowed impulse response. Using two markers, a section of the impulse response can be selected for analysis, e.g. to exclude room reflections. The response comprises the fundamental and 2 nd , 3 rd and higher order harmonics separated in the time domain.
Energy Time Curve	Magnitude of the envelope of the impulse response given in dB. In this representation the direct sound can usually be determined more clearly than in the impulse response.
H(f) Magnitude	Magnitude of the transfer function
Fundamental + Harmonic Distortion	Shows the magnitudes of the fundamental, the harmonic distortion components (from 2 nd to maximal 24 th order).
Harmonic distortion	Ratio of harmonic distortion components (from 2 nd to maximal 24 th order) and fundamental of transfer function in percent or dB respectively

Reference for H(f)	Reference curve for the transfer function that can be imported from clipboard
H(f) Phase	Phase of transfer function
H(f) Nyquist	Nyquist plot of transfer function (imaginary part vs. the real part).
H(f) Minimum Phase	Minimum phase of transfer function
H(f) Excess Phase	Excess phase of transfer function. The excess phase is $\Phi_{\text{excess}} = \text{phase} - \text{minimum phase} - \text{effect of time delay}$.
H(f) Excess Delay	Excess delay of transfer function. The excess delay is the negative derivative of the excess phase.
H(f) Group Delay	Total delay of transfer function. The total delay is the negative derivative of the transfer function phase.
Cumulative Spectral Decay	Cumulative spectral decay for transfer function H(f). The CSD plot illustrates the decay of the individual frequency components after exciting the system with a sine that is suddenly switched off.
Wigner Distribution	Wigner distribution plot for the transfer function
Spectrogram	Spectrogram of the transfer function. A short symmetric data window is used to separate the impulse response into joined sections. The plot shows the spectra of the sections vs. frequency and time.
Stimulus Spectrum	Spectrum of the stimulus
Y1(f) Input Spectrum	Spectrum of the signal acquired on channel 1
Y2(f) Input Spectrum	Spectrum of the signal acquired on channel 2
Calibration Curves	Shows the imported calibration curves. Calibration curves can be imported from the clipboard.
Stimulus Waveform	Waveform of stimulus signal
y1(t) Input Waveform	Waveform of signal acquired on channel 1
y2(t) Input Waveform	Waveform of signal acquired on channel 2
Table Results + Settings	Collection of result and setup parameters

6 Limit Values

Parameter	Min	Max	Unit
Minimal frequency f_{min}	> 0	$< f_{\text{max}}$	Hz
Maximal frequency f_{max}	$> f_{\text{min}}$	87.3	kHz
Resolution	0.05	187.5	Hz
Sweep time	0.005	42.7	s
Averaging	2	256	
Output Voltage at OUT 1 and OUT2		± 9	V_{peak}
Input Voltage at IN1 and IN2		± 10	V_{peak}
Voltage at Terminal SPEAKER 1		300	V_{RMS}
Current at Terminal SPEAKER 1		20	A_{RMS}

7 Applications

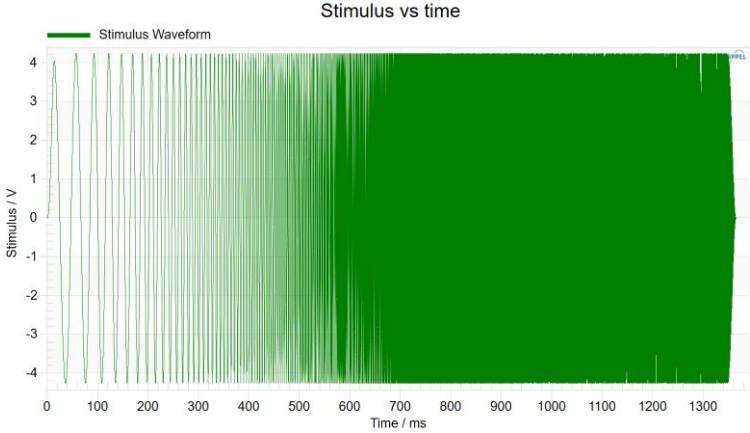
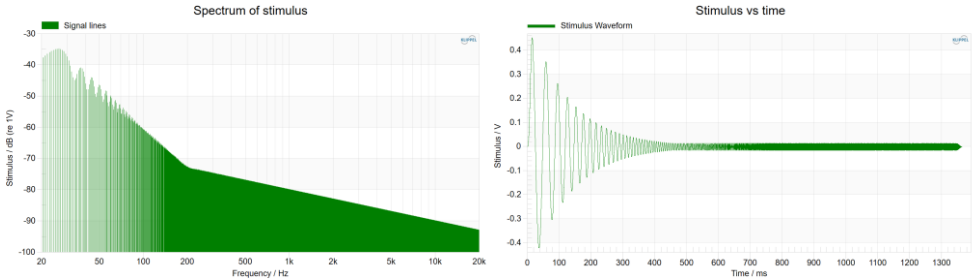
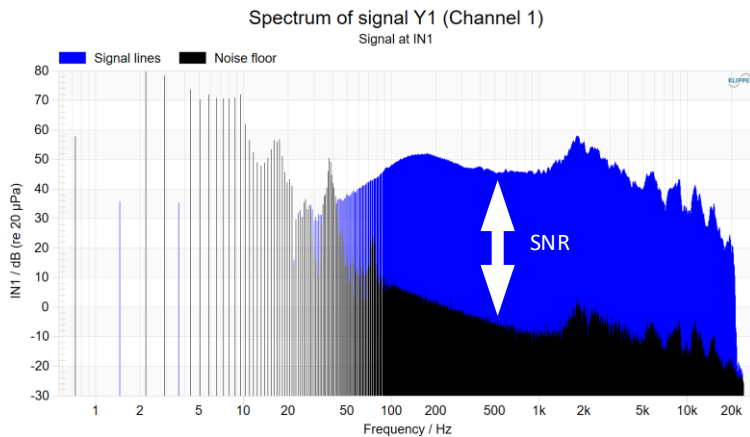
<p>Stimulus</p>	 <p>The module uses a logarithmic sine sweep excitation. This excitation signal gives the highest signal to noise ratio and produces no modulation distortion. If no spectral shaping is applied to the stimulus the crest factor of the time signal is automatically adjusted to the optimal 3 dB.</p>
<p>Shaping of the Stimulus</p>	 <p>The stimulus spectrum can be arbitrarily shaped by importing a shaping curve from the clipboard. This is for instance useful to adapt the stimulus to the noise floor (by increasing the excitation level for noisy frequency bands). Another application is to attenuate low frequencies to protect tweeters.</p>
<p>Spectral Analysis</p>	 <p>A noise floor measurement can be performed prior to the main measurement. Both noise floor and main measurement are subjected to a FFT and plotted in the same graph. This way sufficient excitation and the signal to noise ratio can be checked for the whole frequency band and disturbances (humming etc.) are identified easily.</p>

Impulse Response

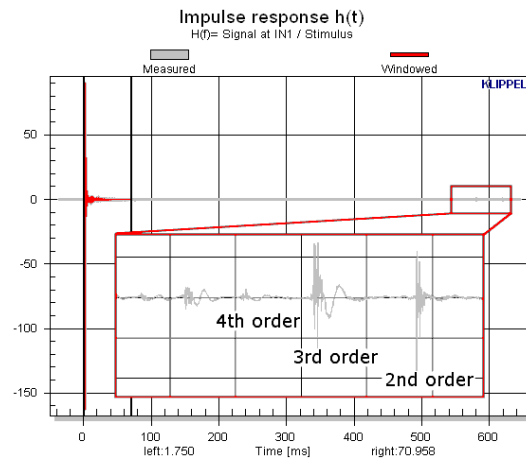

Using two markers the user can separate the direct sound response from early reflections and diffuse field. This way quasi-anechoic measurements can be performed. Due to the logarithmic sweep excitation the linear and the nonlinear response are separated (note the nonlinear harmonic response between 200 ms and 300 ms).

Transfer Function

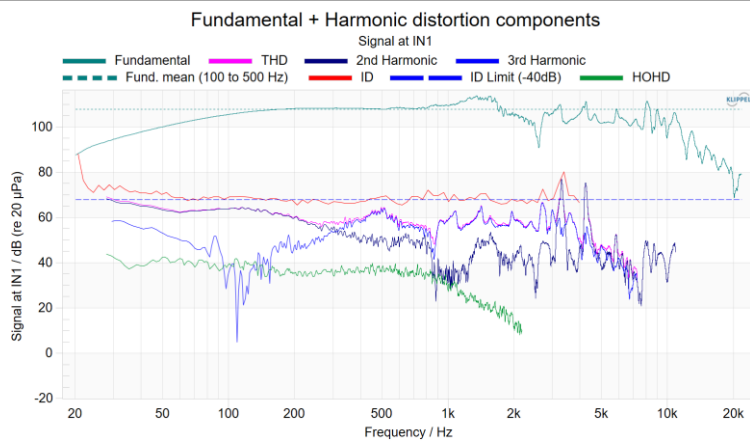

Due to the separation of linear and nonlinear response the transfer function can easily be purified from nonlinear artifacts. Furthermore the individual harmonic distortion components can be extracted from the measured data.

Impedance

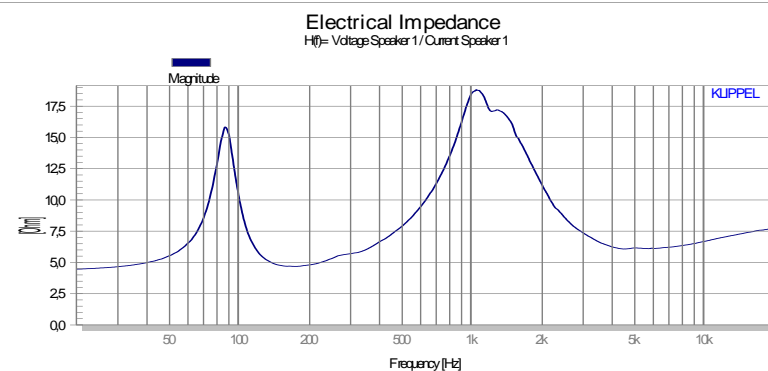

The two channels can be used to measure voltage and current at transducer terminals. Choosing voltage and current as transfer function nominator and denominator the impedance is calculated.

Time-Frequency Transformations

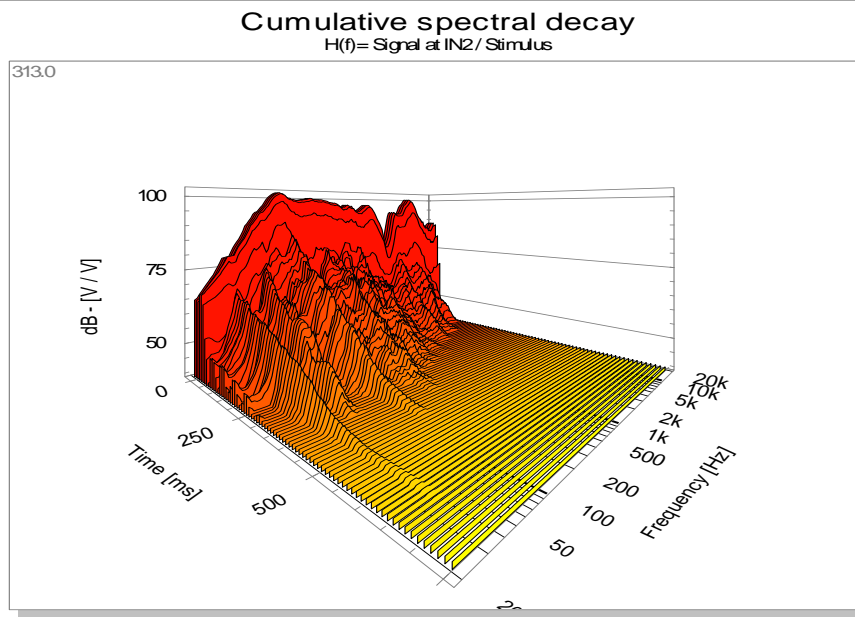

The CSD plot (cumulative spectral decay) illustrates the decay of the individual frequency components after exciting the system with a sine that is suddenly switched off. Box resonance and other unwanted modes are so detected easily.

Spectrogram

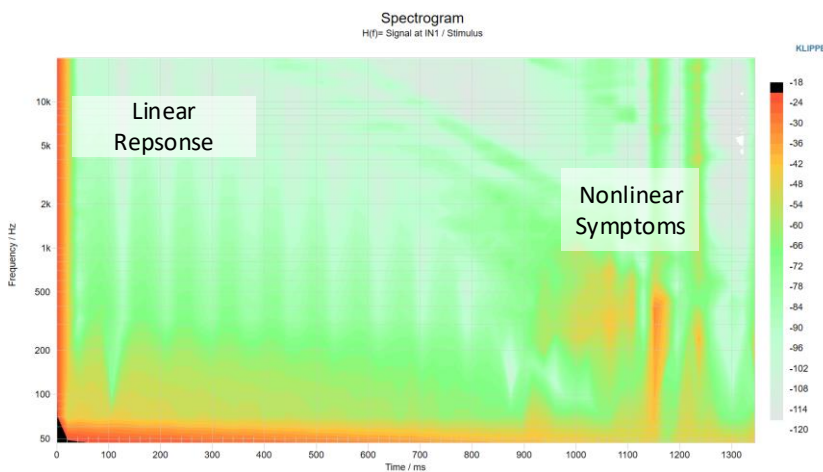

The figure left shows the Spectrogram of the transfer function. It provides the spectral contents of the impulse response vs. time. It is for instance useful to identify the direct sound and the linear and the nonlinear response.

8 Patents

Germany	102009033614, P10214407
USA	12/819,455, 7,221,167
China	201010228820.8, 03108708.6

Find explanations for symbols at:

<http://www.klippel.de/know-how/literature.html>

Last updated: June 04, 2021

