

Check for dominant flux modulation AN11

Application Note to the KLIPPEL R&D SYSTEM (Document Revision 1.3)

DESCRIPTION

The nonlinear relationship between flux density B versus magnetic field strength H of the magnetic circuit generates a permeability (and inductance) which varies with the voice coil current i . This causes nonlinear interactions (“flux modulation”) between the static magnetic field generated by the magnet and the ac field generated by the voice coil current. This application note describes a measurement technique based on a two-tone intermodulation measurement to check for dominant flux modulation as dominant source of distortion.

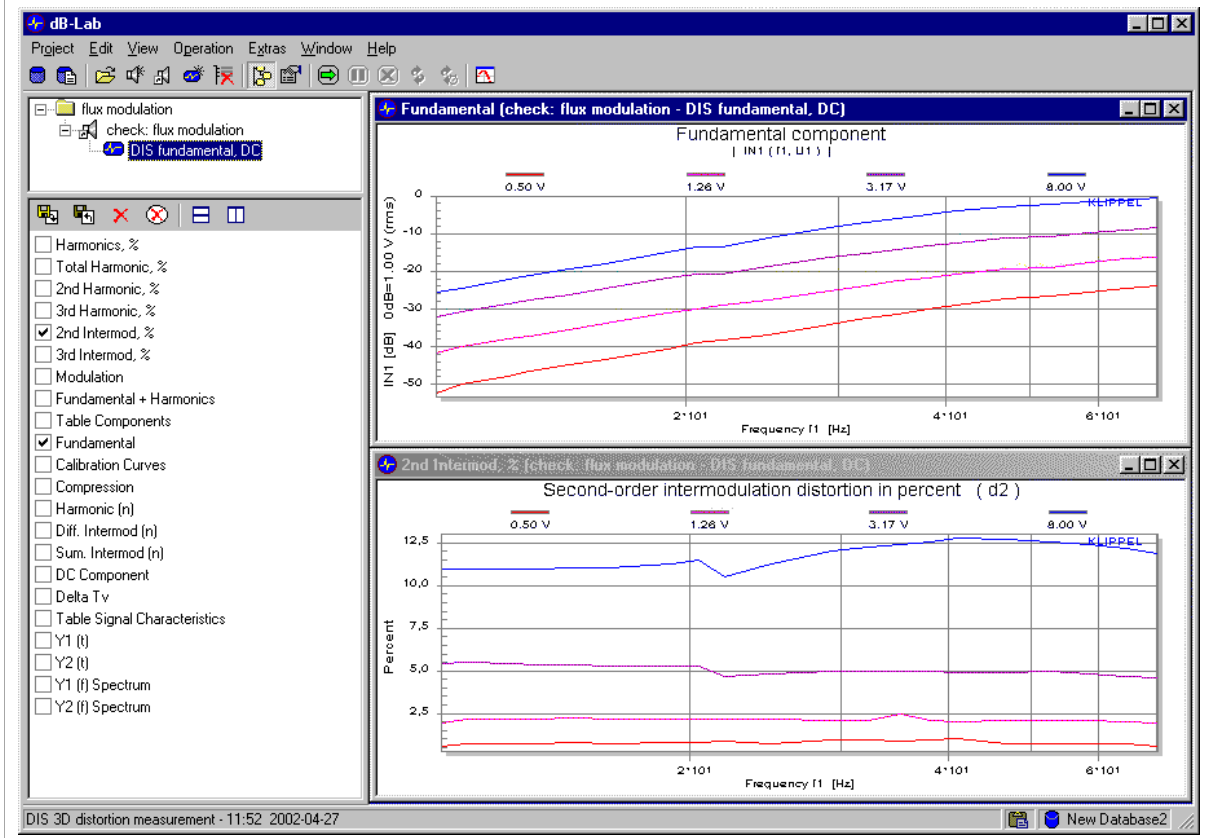

CONTENT

1	Flux Modulation	2
2	Using the DIS Module	5
3	Setup Parameters for DIS Module.....	5
4	Examples	6
5	More Information.....	7

1 Flux Modulation

Causes for Flux modulation

In electro-dynamical transducers, there is an interaction between the static dc field generated by the magnet and the magnetic ac field generated by the voice coil current. This is commonly called "flux modulation". The dominant cause is the nonlinear relationship between magnetic field strength H and flux density (induction) B as shown in Figure 1.

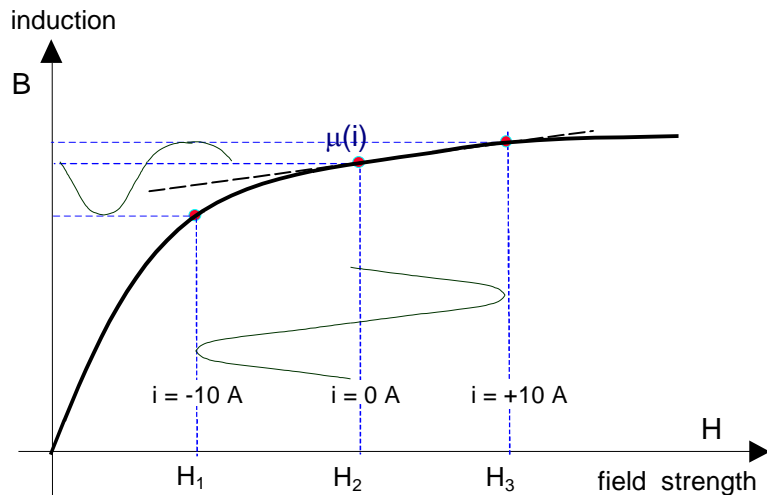

Figure 1: Flux density B versus magnetic field strength H of the magnetic circuit showing that the permeability $\mu(i)$ depends on the voice coil current i .

For no current the permanent magnet produces the field strength H_2 which determines the working point in the $B(H)$ -characteristic. A high positive current ($i = 10 \text{ A}$) increases the total field strength H_3 where the iron is more saturated and the permeability μ is decreased. Contrary at negative current ($i = -10 \text{ A}$) the total field strength is decreased giving a higher value of μ . The effect of the varying permeability $\mu(i)$ is also called "flux modulation". The ac current also generates a hysteresis loop, which corresponds with the losses in the iron material during one period of a sinusoidal current.

**Lumped
Parameter
Model**

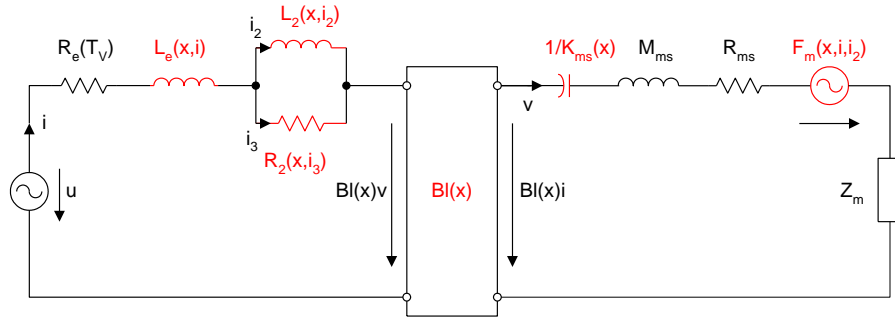

Figure 2: Electrical equivalent circuit of the electro-dynamical transducer

The magnetic ac-flux increases the impedance at higher frequencies that cannot be described by an ideal inductance. Special models (Leach, Wright, cascaded LR-network) are required to describe losses generated by eddy currents in the iron material. The discrete model using an inductance $L_e(x,i)$ in series with a second inductance $L_2(x,i)$ shunted by a resistor $R_2(x,i)$ as shown in Figure 2 is a good candidate to consider the nonlinear dependency on displacement and current. The particular parameters depend on the frequency range over which the fitting is performed.

For most applications it is also convenient to use a simple approximation which neglect the nonlinear interactions between current and displacement and use the same nonlinear curve shape for the displacement varying parameters

$$\frac{L_e(x, i = 0)}{L_e(0)} \approx \frac{L_2(x, i = 0)}{L_2(0)} \approx \frac{R_2(x, i = 0)}{R_2(0)}$$

and the current varying parameters

$$\frac{L_e(i, x = 0)}{L_e(0)} \approx \frac{L_2(i, x = 0)}{L_2(0)} \approx \frac{R_2(i, x = 0)}{R_2(0)}$$

This approximation reduces the amount of data used in loudspeaker diagnostic and loudspeaker design. The nonlinear characteristics of $L_e(x)$ versus displacement x and $L_e(i)$ versus i and the values $L_2(0)$ and $R_2(0)$ at the rest position $x=0$ are sufficient in most applications to describe the nonlinear characteristic of the para-inductance.

Symptoms of $L_e(i)$

The variation of the permeability expressed by the current varying inductance $L_e(i)$ causes a multiplication of current signals prior to the differentiation produces characteristic symptoms in the output signal:

The intermodulation distortion measurement with varying bass tone frequency ($f_s/2 < f_1 < 2f_s$) and constant voice tone ($f_2 = 8f_s$) reveals a unique symptom. The *IMD* response has a characteristic minimum at the resonance frequency f_s as shown in Figure 3.

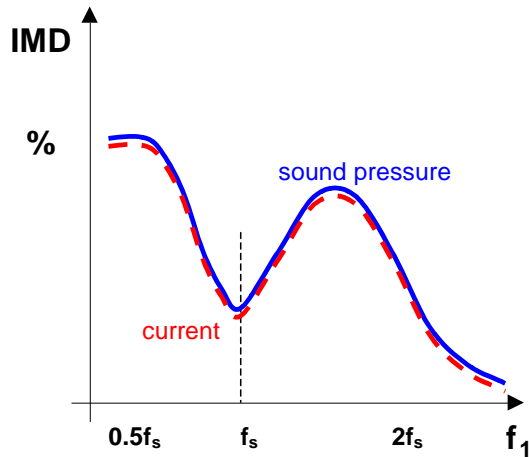

Figure 3: Frequency response of Intermodulation Distortion (*IMD*) in sound pressure and current which is characteristic for current varying inductance $L(i)$ (sweeping the *bass* tone)

The *IMD* distortion and the harmonic distortion at higher frequencies measured in sound pressure and current are also identical. Contrary to the displacement varying nonlinearities ($BI(x)$, $K_{ms}(x)$ and $L_e(x)$). These nonlinearities can also produce significant harmonic distortion (*HD*, *THD*) in the input current and sound pressure output as shown in Figure 4.

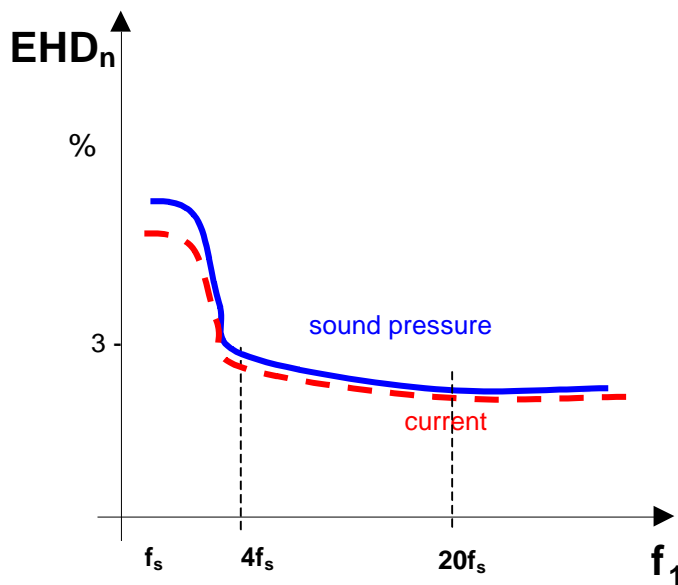



Figure 4: Frequency response of equivalent harmonic input distortion (*EHD*) measured in sound pressure and current which is characteristic for a current varying inductance $L(i)$

2 Using the DIS Module

Requirements	<p>The following hardware and software is required</p> <ul style="list-style-type: none"> • Distortion Analyzer + PC • DIS software module + dB-Lab • Microphone
Setup 	<ul style="list-style-type: none"> • Connect the microphone to the input IN1 at the rear side of the DA. • Set the speaker in the approved environment and connect the terminals with the output Speaker 1. • Switch the power amplifier between the connectors OUT1 and Amplifier.
Preparation	<ul style="list-style-type: none"> • Create a new object • Assign a new DIS operation based on the template <i>DIS IM Dist. (bass sweep) AN11</i> • Determine the resonance frequency of the driver
Measurement	<ol style="list-style-type: none"> 1) Open property page <i>Stimulus</i> and enter starting frequency $f_{start}=f_s/4$ and last frequency $f_{end}=2f_s$. Set frequency of the second tone to $f_2=9f_s$. (Please make sure, $f_2>4.5*f_1$ and f_1 is not a divider of f_2) Set the maximal voltage U_{end} to a high value just permissible for the particular driver. 2) Start the measurement 3) Open property page <i>Display</i> and select <i>Current Speaker 1</i> in drop down box <i>Selected signal</i>. 4) Open the windows <i>2nd Intermod, %</i> and <i>3rd Intermod</i>, and inspect the variation versus frequency. Copy the curves and paste them into the same diagram (for storing purposes). This allows to easily compare the results after the next measurement step. 5) Select <i>Signal at IN1</i> in drop down box <i>Selected signal</i> in property page <i>Display</i>. Compare the distortion in result window <i>2nd Intermod, %</i> and <i>3rd Intermod</i>, at $f_1=f_s$. A clear minimum at f_s in current and sound pressure is a clear indication for dominant flux modulation.

3 Setup Parameters for DIS Module

Template	<ul style="list-style-type: none"> • Create a new Object, using the operation template <i>IM Dist. (bass sweep) AN11</i> in dB-Lab. If this database is not available, you may adjust the default DIS setup as described below. You may also modify the setup parameters according to your needs.
Default settings	<ol style="list-style-type: none"> 1) Open the property page <i>Stimulus</i>. 2) Select Harmonics + Intermodulations (f2) in the drop down box <i>Mode</i>. 3) Select Sweep in group Voltage U₁. Set U_{start} to 0.1 V_{rms}, U_{end} to 8 V_{rms}, Points to 4 and Spaced to <i>lin</i> in the same group. Make sure the signal level is appropriate for loudspeaker. 4) Set U₂/U₁ to 0 dB. 5) Select Sweep in group Frequency f1 and specify a sweep with 20 points spaced logarithmically between $f_{start}=f_s/4$ and $f_{end}=2f_s$. Select f2 in group f2 and set the frequency $f_2=9f_s$. (Please make sure, $f_2>4.5*f_1$ and f_1 is not a divider of f_2). 6) Select Additional excitation before measurement and set it to 0.1 s. 7) Open property page Protection. 8) Select Monitoring: Voice coil temperature and amplifier gain. Select Interrupt measurement if: increase of voice coil temperature exceeds and set the temperature to 100 K.

- 9) Open property page Input. Select Mic IN 1 in the group (Channel 1) Y1 and Is Current Speaker 1 in group Y2 (Channel 2).
- 10) Open property page Display. Select Current Speaker 1 in drop down box State signal and 2D plot versus f1 in group Plot style.

4 Examples

Parameters

The LSI module of the Klippel R&D System measured the parameters of an automotive loudspeaker. The nonlinear inductance parameters are presented below:

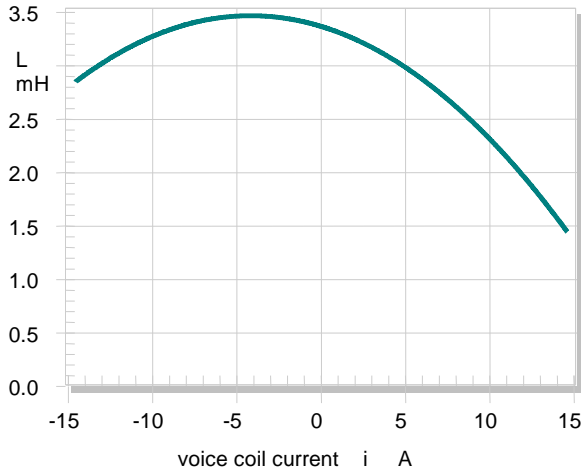

Figure 5: Inductance $L_e(i)$ versus current i

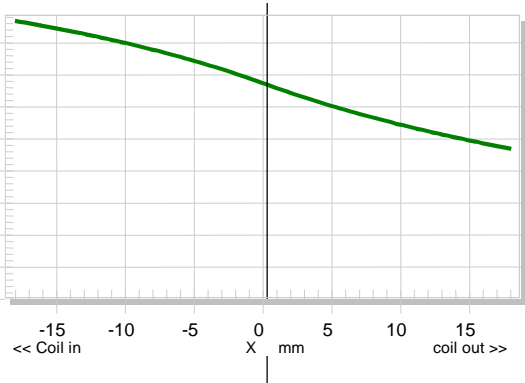
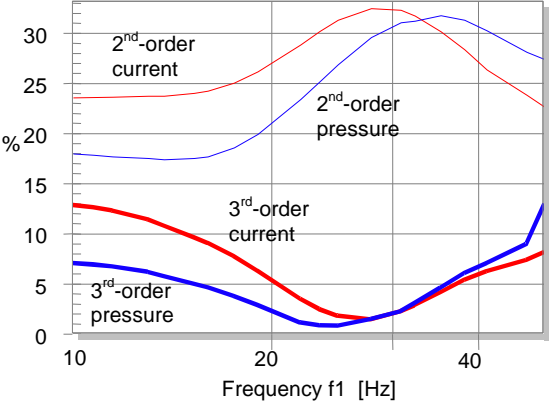

Figure 6: Inductance $L_e(x)$ versus displacement x

The asymmetrical shape is typical for a motor without any shorting material. The inductance with 3.5 mH dominates the electrical input impedance at higher frequencies. During the large signal, parameter measurement (LSI) the peak value of current and displacement exceeded 15 ampere and 18 mm, respectively, which cause significant variations of electrical input impedance at higher frequencies. The $L_e(x)$ is more asymmetric than the $L_e(i)$ characteristic.

<p>Symptoms</p>	<p>The intermodulation between a bass tone at variable frequency f_1 and the voice tone at fixed frequency $f_2= 300$ Hz is shown in Figure 7.</p>  <p>Figure 7: 2nd-order and 3rd-order intermodulation <i>IMD</i> in measured in voice coil current and sound pressure output of loudspeaker 3 (varied bass tone, $f_2= 300$ Hz)</p> <p>Like the harmonic distortion, the intermodulation in current and sound pressure output is in the same order of magnitude. This is a characteristic symptom of both inductance nonlinearities $L_e(x)$ and $L_e(i)$. The 2nd-order intermodulation IMD_2 has a maximum at the resonance frequency that is typical for $L_e(x)$-nonlinearity varying with displacement. The 3rd-order distortion IMD_3 has a dip at the resonance frequency f_s which is the characteristic symptom for the $L_e(i)$-nonlinearity because the current becomes minimal there.</p>
------------------------	--

5 More Information

<p>Related Application Notes</p>	<p>W. Klippel, “Loudspeaker Nonlinearities – Causes, Parameters, Symptoms,” preprint presented on the 119th Convention of the AUDIO Eng. Soc. in New York, 2005 October 7-10, preprint 6584.</p> <p>Engineering Poster “Loudspeaker Nonlinearities – Causes, Parameters, Symptoms”, available from the KLIPPEL GmbH</p>
<p>Related Specification</p>	<p>“DIS”, S4</p>
<p>Software</p>	<p>User Manual of the KLIPPEL R&D SYSTEM.</p>

Find explanations for symbols at:

<http://www.klippel.de/know-how/literature.html>

Last updated: 08.01.16

