

HOLOGRAPHIC LOUDSPEAKER TESTING

ASSESSING RADIATED SOUND IN 3D SPACE

FUNDAMENTALS

Spherical Wave Expansion

The complex transfer function $H(f, r)$ relating loudspeaker input $u(t)$ to sound pressure $p(r)$ at a particular point r under free field conditions, is described by the sum of orthonormal basis functions $B(f, r)$ and its weighting complex coefficients $C(f)$.

$$H(f, r) = C(f) \sum_{n=0}^{\infty} c_{nm}(f) \cdot h_n^{(2)}(kr) \cdot Y_n^m(\theta, \phi)$$

The basis functions $B(f, r)$ are general solutions of the wave equation in spherical coordinates, comprising Hankel functions of the second kind $h_n^{(2)}$ and spherical harmonics Y_n^m . The coefficients $c_{nm}(f)$ and the maximum order N of the expansion depend on the properties of the specific loudspeaker being tested.

Orthogonal Decomposition

The decomposition into orthogonal basis functions $B(f, r)$ provides a comprehensive representation of the 3D output without redundancy. The maximum required order N of the expansion depends on the complexity of the directivity pattern generated by the loudspeaker. The total sound power generated by a compact sound source at low frequencies can be described by a low order of expansion ($N=3$) where the monopole ($n=0$), dipoles ($n=1$) and quadrupoles ($n=2$) are dominant.

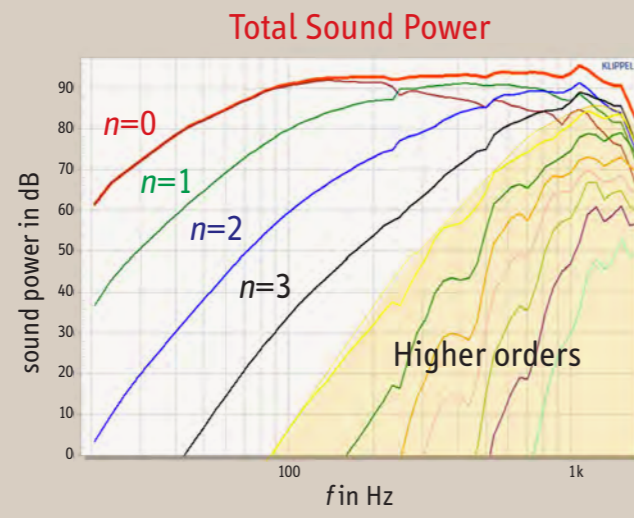

Higher-order terms are required to model the directivity at higher frequencies in order to achieve sufficient angular resolution and accuracy.

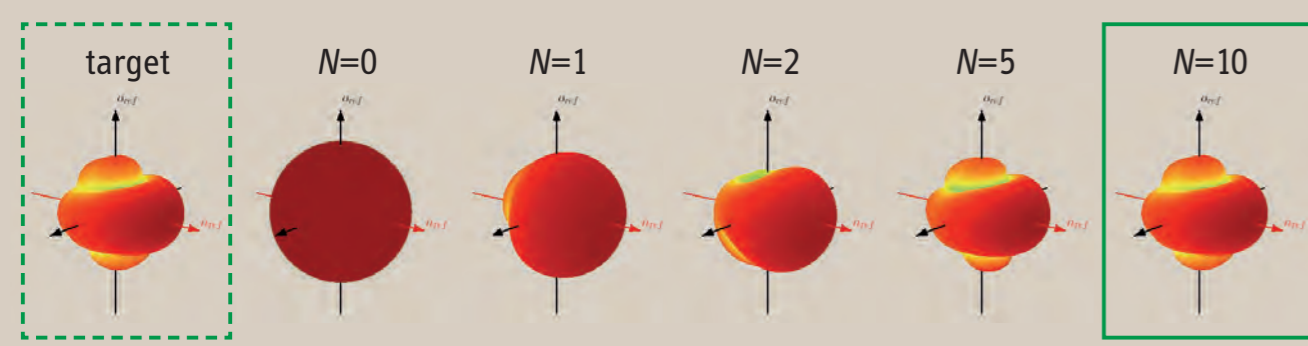

Sound Separation

Measurements of the sound pressure generated by a loudspeaker in a non-anechoic environment show interference between the direct sound component and the reflections produced by the room (e.g. walls). At high frequencies the direct sound can be isolated by windowing the impulse response. At low frequencies the windowing technique requires a large distance between the speaker and the reflecting boundaries in order to provide sufficient spectral resolution.

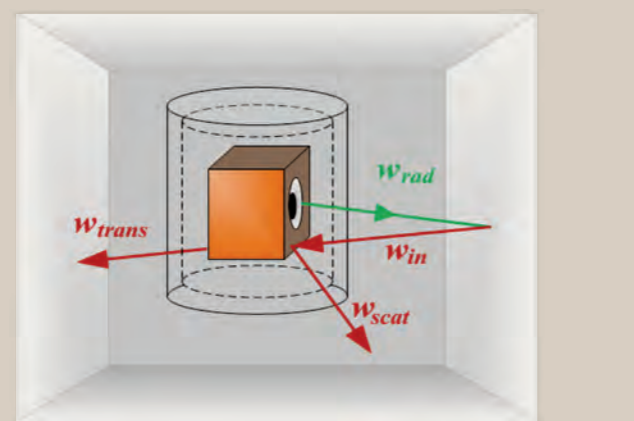

Holographic processing of the sound pressure data, scanned in two layers, separates the radiated direct sound W_{rad} from the reflections W_{ref} and W_{scat} .

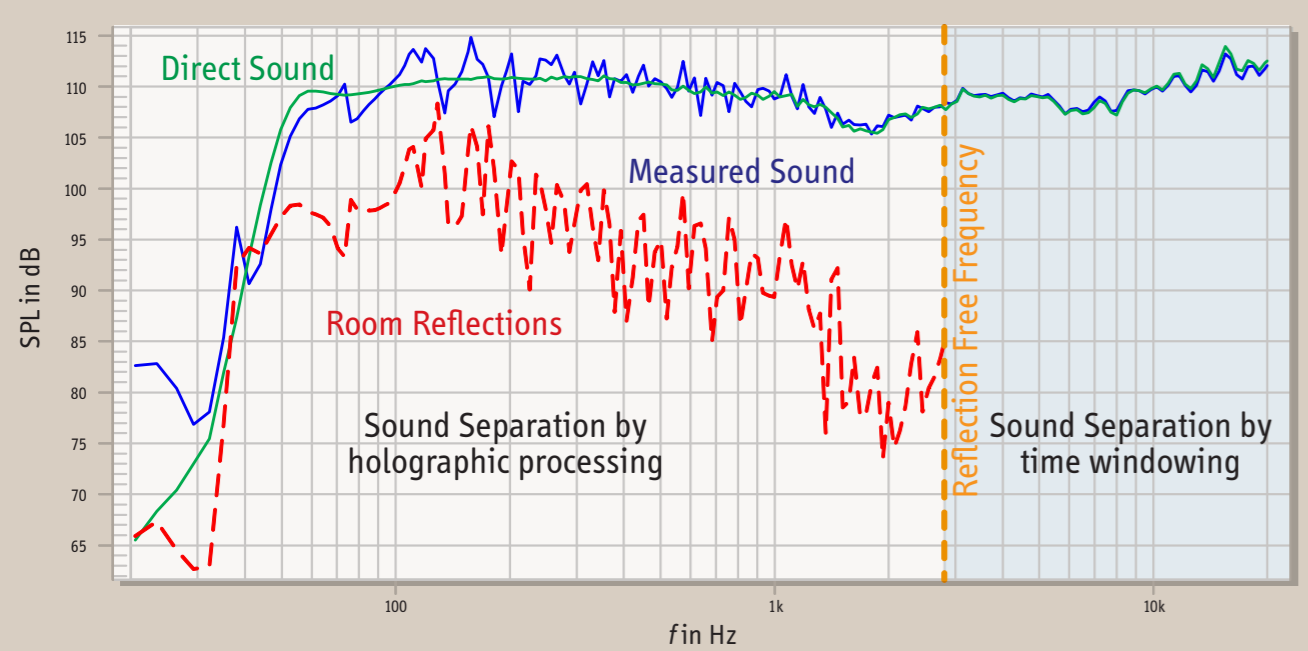

Sound Field Extrapolation

In the far field, the sound pressure p is directly proportional to the distance r and can be calculated using the $1/r$ law: „Doubling the distance reduces the sound pressure level by 6dB“.

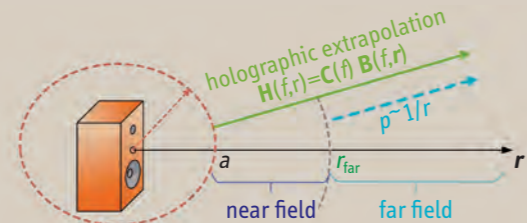

In the near field the $1/r$ law is not valid due to the phase shift between the sound pressure and velocity, which increases the apparent sound power for small values of r . The spherical wave expansion can describe the sound pressure at any point in 3D space outside the scanning surface (near and far field).

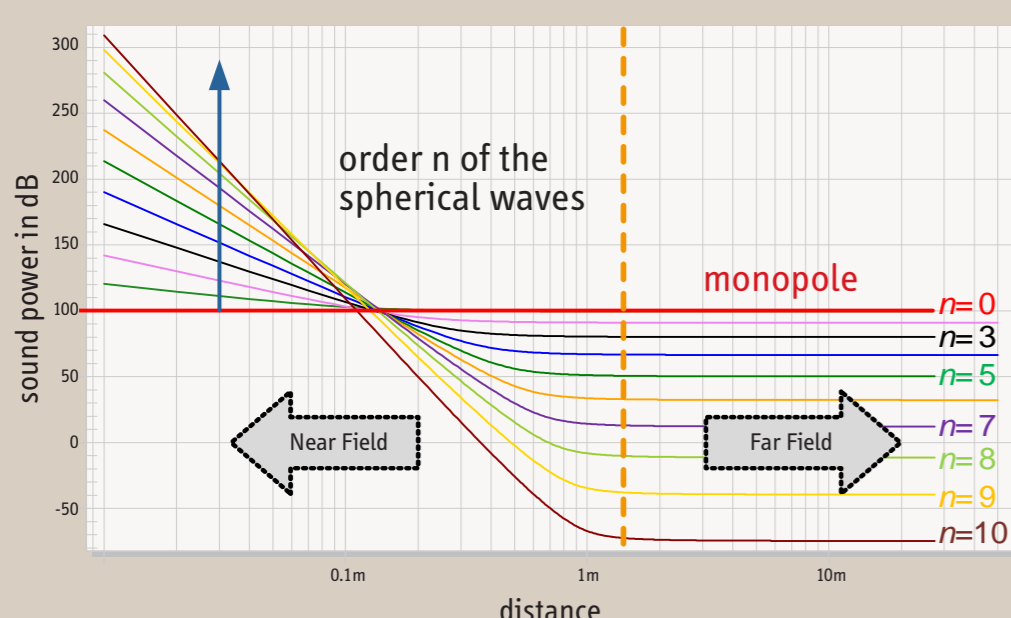

Apparent sound power of the spherical waves of order $n=0$ decreases in the near field and stays constant in the far field of the sound source.

MEASUREMENT

Near Field Scanning

The sound field is measured using two cylindrical or hemispherical surfaces in the device's near field. While still generating the same angular resolution of the directivity pattern, the holographic approach requires a lower number of measurement points than traditional techniques.

Number of points	Application
1	on axis response
100	sound power
1000	directivity
5000	professional systems



The measurement of sound pressure in the near field, provides accurate amplitude and phase information with a high signal to noise ratio (SNR) by minimizing the impact of air convection and temperature variation on the propagating sound wave. To ensure constant interaction between the loudspeaker and the room, the microphone is moved around the loudspeaker on two cylindrical scanning surfaces, instead of rotating the loudspeaker on a turntable. This is required in order to separate the direct sound from the room reflections and will simplify the measurement of heavy loudspeakers.

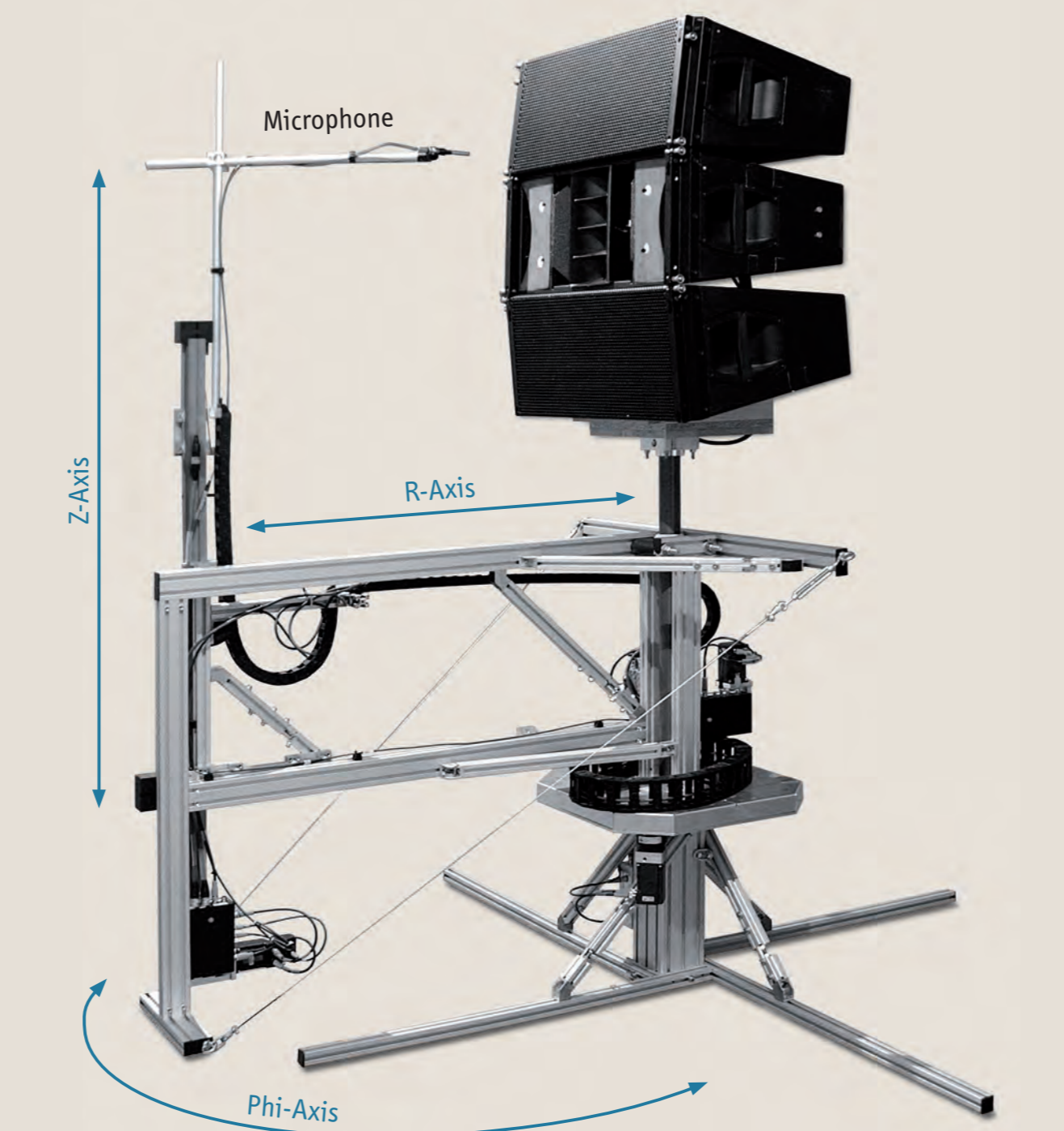

Parameter Identification

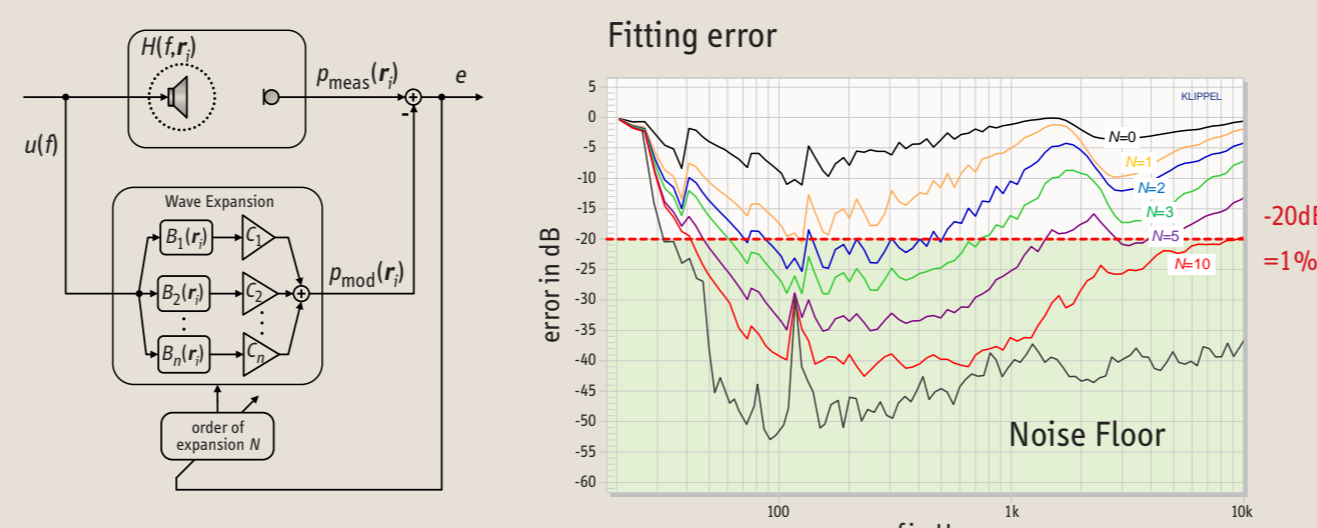

Double layer scanning produces redundant data, which is used to check the accuracy of the measurements. The fitting error E_{fit} evaluates the similarity between measured pressure $p_{meas}(r_i)$ and modeled pressure $p_{mod}(r_i)$ at all measurement points r_i .

$$E_{fit} = \frac{\sum_{i=1}^M |p_{meas}(r_i) - p_{mod}(r_i)|^2}{\sum_{i=1}^M |p_{meas}(r_i)|^2} \cdot 100\%$$

Single Point SPL Measurement

Accurate far field data can be determined by only performing a single measurement and by using correction curves. For any loudspeaker (1) correction curves can be easily generated by comparing the total sound pressure (direct sound and room) at the microphone position r_0 and the direct sound pressure (no room effects) calculated using the full scan data and holographic processing. The correction curve can be applied to other loudspeakers (2) of similar geometry with the same loudspeaker and microphone position in the room.

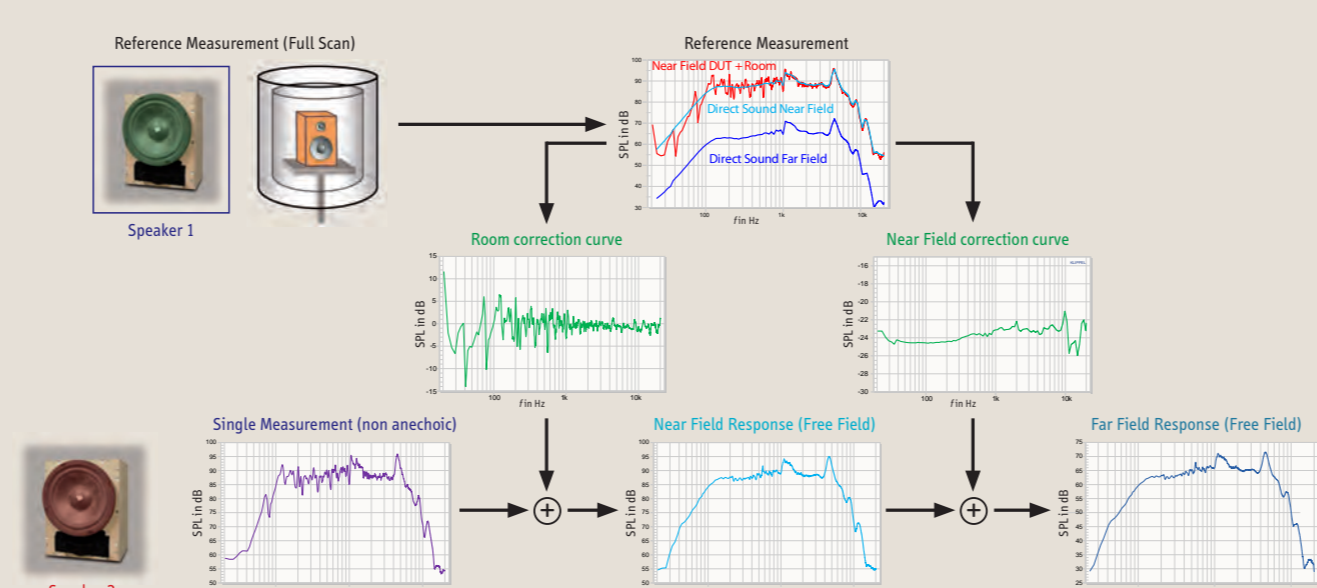

APPLICATIONS

Far Field Characteristics

The frequency response of the loudspeaker at any point in the far field can be extrapolated from near field data.

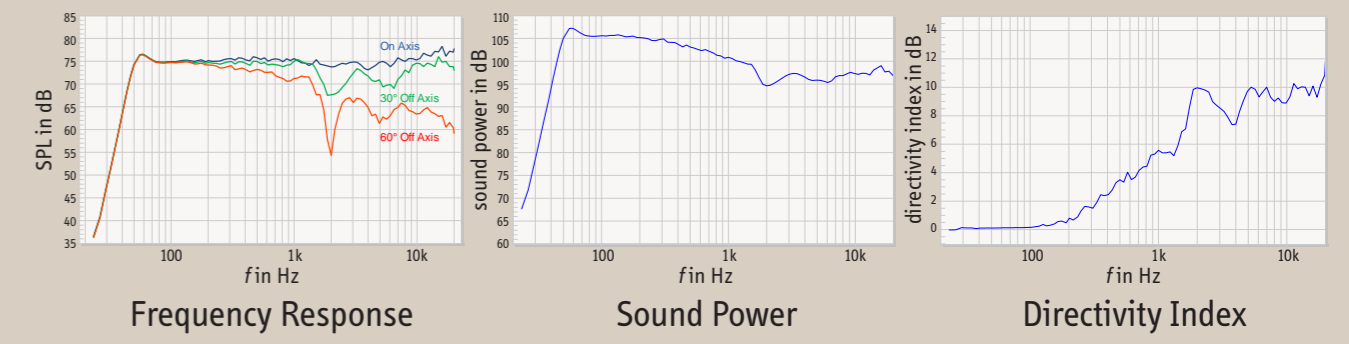

3D Directivity

Traditional directional characteristics are calculated based on the wave expansion and can be exported to external sound field simulation software with any desired angular resolution (e.g. 1°).

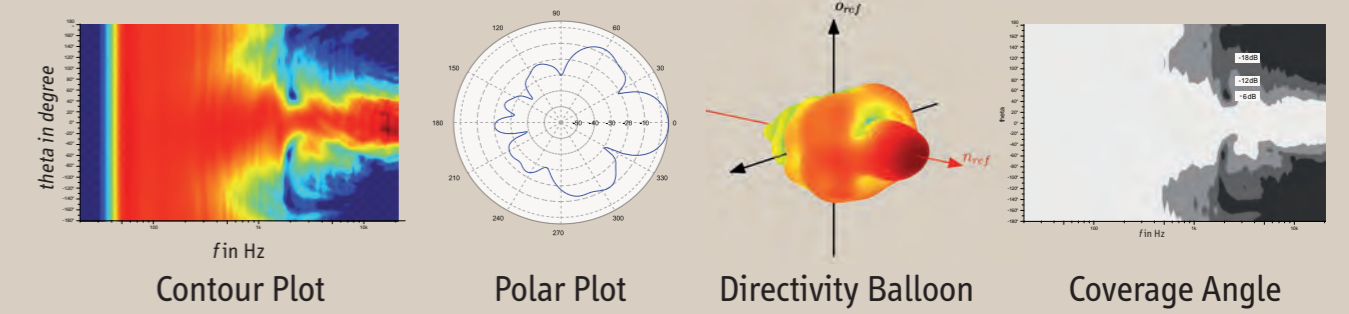

Near Field Characteristics

Near field characteristics are especially relevant for studio monitors, smart phones, laptops and other personal audio devices. An observation plane can be positioned in 3D space to investigate the spatial SPL distribution in the near field of the audio device. The holographic measurement provides accurate phase information to compute the wave propagation into the far field, helping visualize the binaural perception of sound.

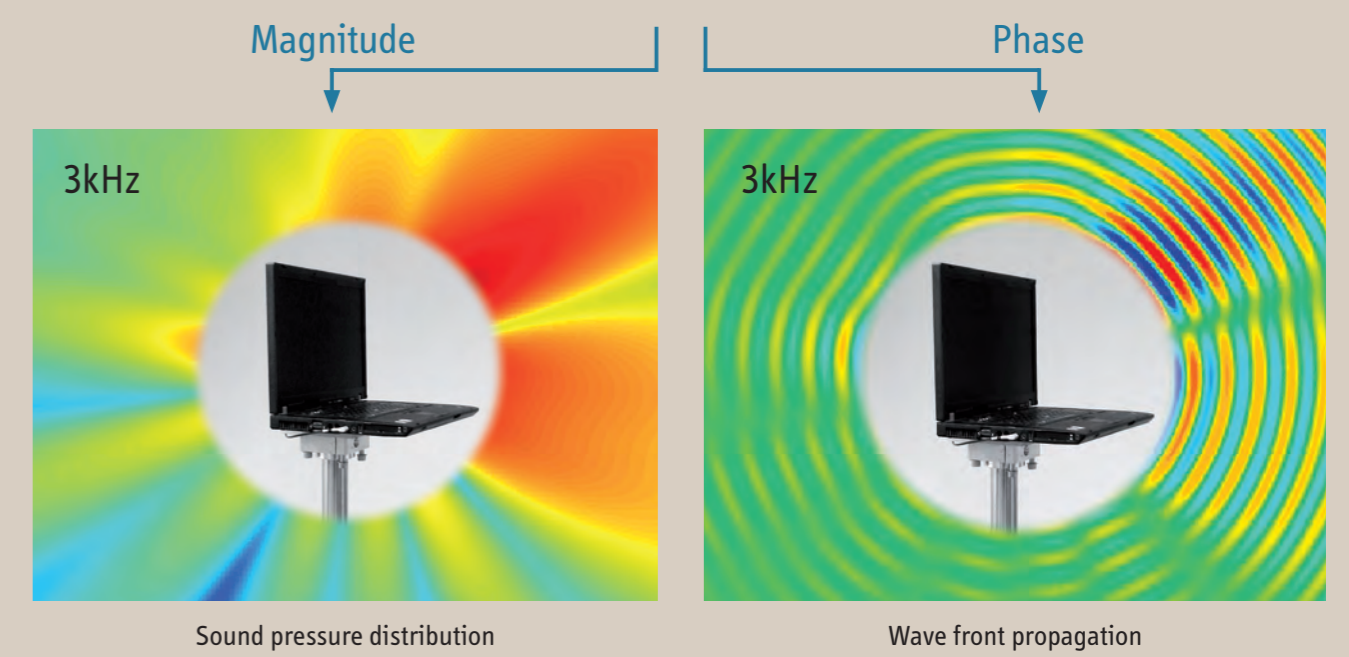

Simplified Interpretation

The CEA 2034 standard specifies meaningful loudspeaker responses at specific points, for home applications. This is helpful when considering the interaction with a room and when comparing loudspeakers regarding their performance at defined listening positions.

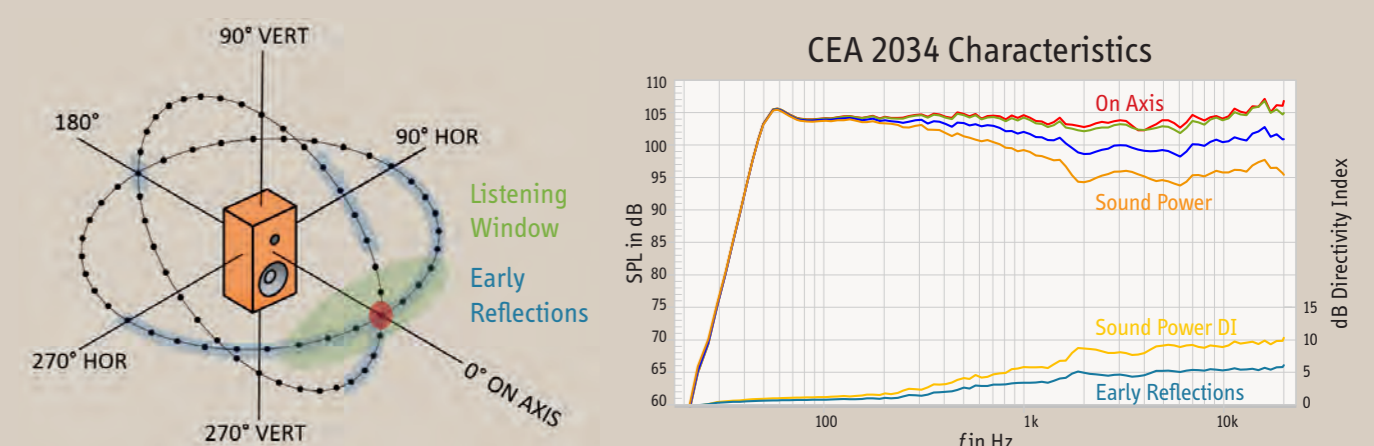

Testing personal audio devices, the IEC 62777 standard specifies the meaningful characteristics in personal acoustic zones in the near field of the sound source.

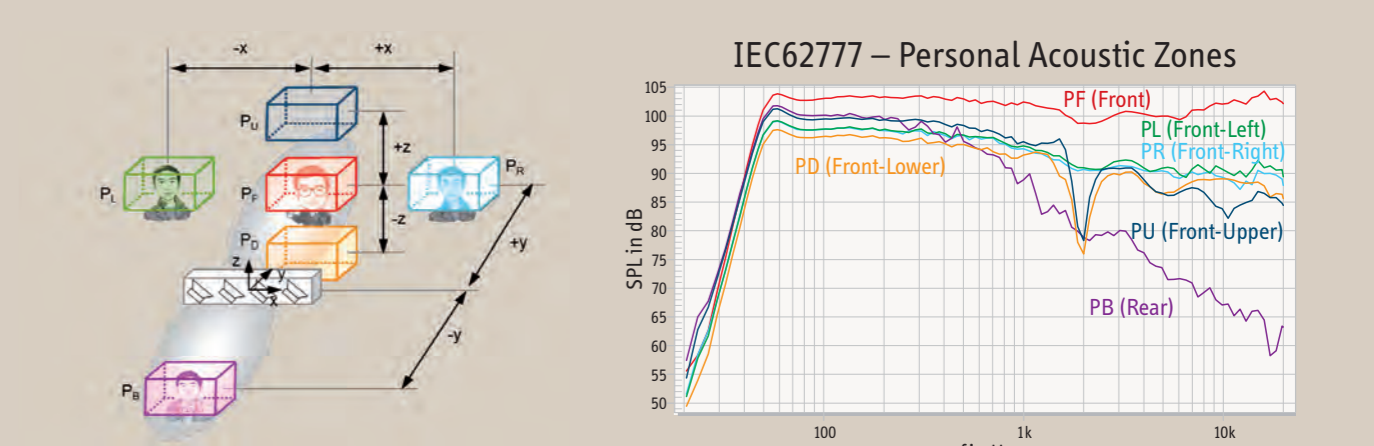

Distributed Sound Sources

The directivity of distributed sound sources (line arrays, sound bars) can be determined by measuring each individual transducer of the loudspeaker system. Thereby, the measured characteristic of each transducer also includes shadowing and diffraction effects of the loudspeaker cabinet. After holographic processing, the total radiated sound pressure is calculated by superimposing the individual sound sources. By applying separate filters on each transducer (e.g. delay, gain), the directivity of the active system can easily be controlled (beam steering).

